

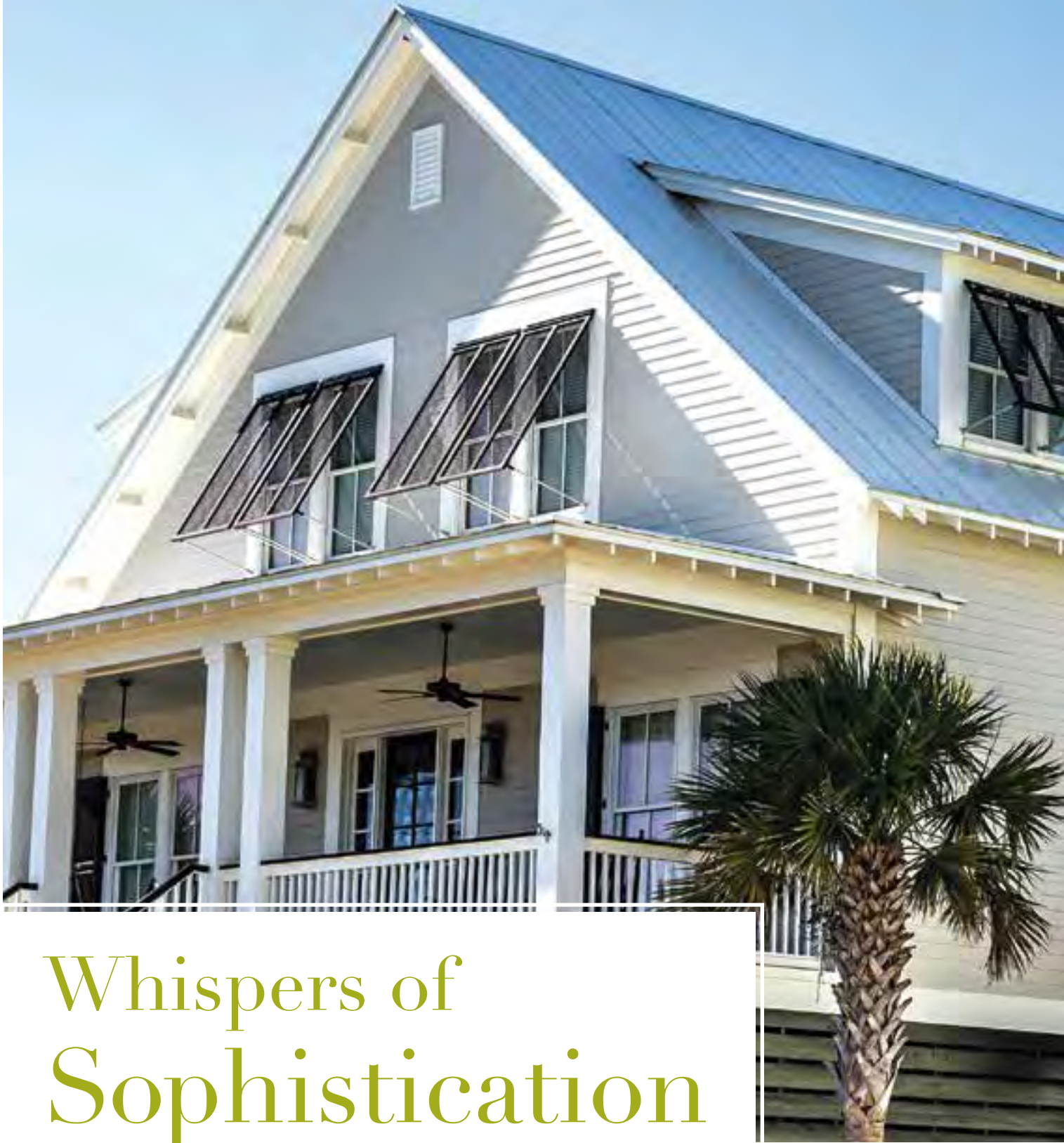

Atlantic
Premium Shutters®

BECAUSE EVERY HOME
TELLS A STORY.



Whispers of Sophistication

Combining style, craftsmanship and durability, Atlantic Premium Shutters are as customizable as they are timeless. They offer a broad choice of styles that are architecturally and historically accurate - from classically traditional to uncommonly elegant to boldly adventurous.

Homes Reflect Personality.



In a cookie cutter world, Atlantic Premium Shutters can help your home, or your project, stand out. All while standing up to the inevitable wear and tear of time. With Atlantic Premium Shutters, you can make sure that personality is heard loud and clear.



Architectural Collection | Louvered Colonial | Board and Batten Red 650

The Architectural Collection

Repeating history, accurately and beautifully.

Uncompromisingly Durable

The shutters of the Architectural Collection beautifully reflect the time-honored look and functionality of traditional shutter design. Made with superior-quality materials, these shutters provide a lifetime of classic exterior charm without any maintenance required. The fully-functional shutters of the Architectural Collection are comprised of our Panel, Louvered Colonial, Combination and Bahama shutter styles.

Hand-crafted Quality

The Architectural Collection uses modern materials with a centuries-old technique of mortise and tenon joinery to provide the strongest structural joint. And our shutters are hand-cut and hand-assembled to meet your exact specifications.

Durable Down to the Last Detail

Architectural Collection shutter frames feature unsurpassed durability due to the strength of the marine-grade fiberglass used in our proprietary stile and louver designs.

We use our own proprietary, exterior grade composite wood to manufacture solid, sturdy shutter panels. The shutter rails are crafted from single-sheet, structural-grade PVC delivering strength and stability, and allowing for custom rail sizing in combination and louver style only. The specialized tooling of each of our selected materials enables the creation of fine, historically-correct detail.

Finishing Touches

Our advanced finishing process gives you enduring, vibrant colors that last a lifetime and our partnership with the world leader in finishes allows us to match almost any color. Meaning you can find the color you seek. And be sure you won't have to go through the agony of locating it ever again.



Panel | Midnight Sky 639

Panel

Panel shutters offer a clean, handsome and elegant look for a variety of historic or modern home styles. The artistic depth and curves on the panels dramatically catch sunlight and impart alluring shadows. Popular two-panel and three-panel designs bring deep texture and solid, artistic appeal. A wealth of options is available for added sophistication, limited only by your imagination.



Standard



Single Panel



Extra Panel



Custom Rail Location



Arch or Radius Top



Panel & Louvered Colonial | Forest Green 633



Single Panel with Vertical Cut Profile



Chamfered Panel



Flat Panel



V-Groove Flat Panel



Louvered Colonial

True to centuries-old design, our Louvered Colonial shutters provide timeless elegance with the crisp lines of genuine open louvers. Just as louvered shutters performed the duties of keeping inclement weather out, protecting the home and allowing ambient light, our shutters today provide the same functionality with integrity that will stand throughout your lifetime.



Standard



Additional Rail



Faux Tilt Rod



Louvered Colonial & Bahama | Tempest Blue 666



Custom Top or
Bottom Rail
Sizes



Solid Arch Top



Horns



Rabbeted Edge

The **Architectural** Collection



Combination

Combination shutters provide the creative outlet for homeowners and architects with a passion for the utmost in unique style. These shutters enable the full creativity of combining design elements of Raised Panel and Louvered Colonial shutters. Allowing a wide spectrum of personalized details, our Combination shutters can exceptionally enhance historical themes or create a signature look that's exclusively your own.

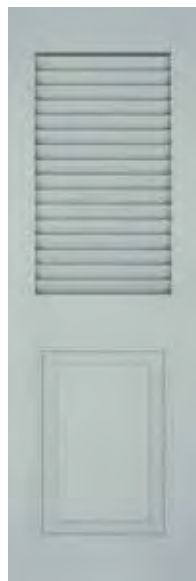

Standard



Extra Panel



Additional Rail



Faux Tilt Rod



Custom Top or Bottom Rail Sizes



Combination | Roycraft Copper Red 668



Solid Panel
Arch Top



Rabbeted Edge



The **Architectural** Collection



Bahama | Tempest Blue 666

Bahama

Atlantic's Bahama shutters bring refreshingly clean, versatile design. Inspired by the elegant functionality of shutters found throughout the Caribbean, Bahama shutters block out intense UV rays that can damage interiors, while allowing soft ambient light and refreshing breezes to pass through. Their airy, relaxed design offers a sophisticated privacy solution. Bahama shutters can be paired with various shutter styles to deliver a dramatic look. These shutters are a longtime favorite in coastal and tropical locales.

The *Architectural* Collection



Bahama | Black 632



Standard



Additional Rail



Additional Vertical Mullion

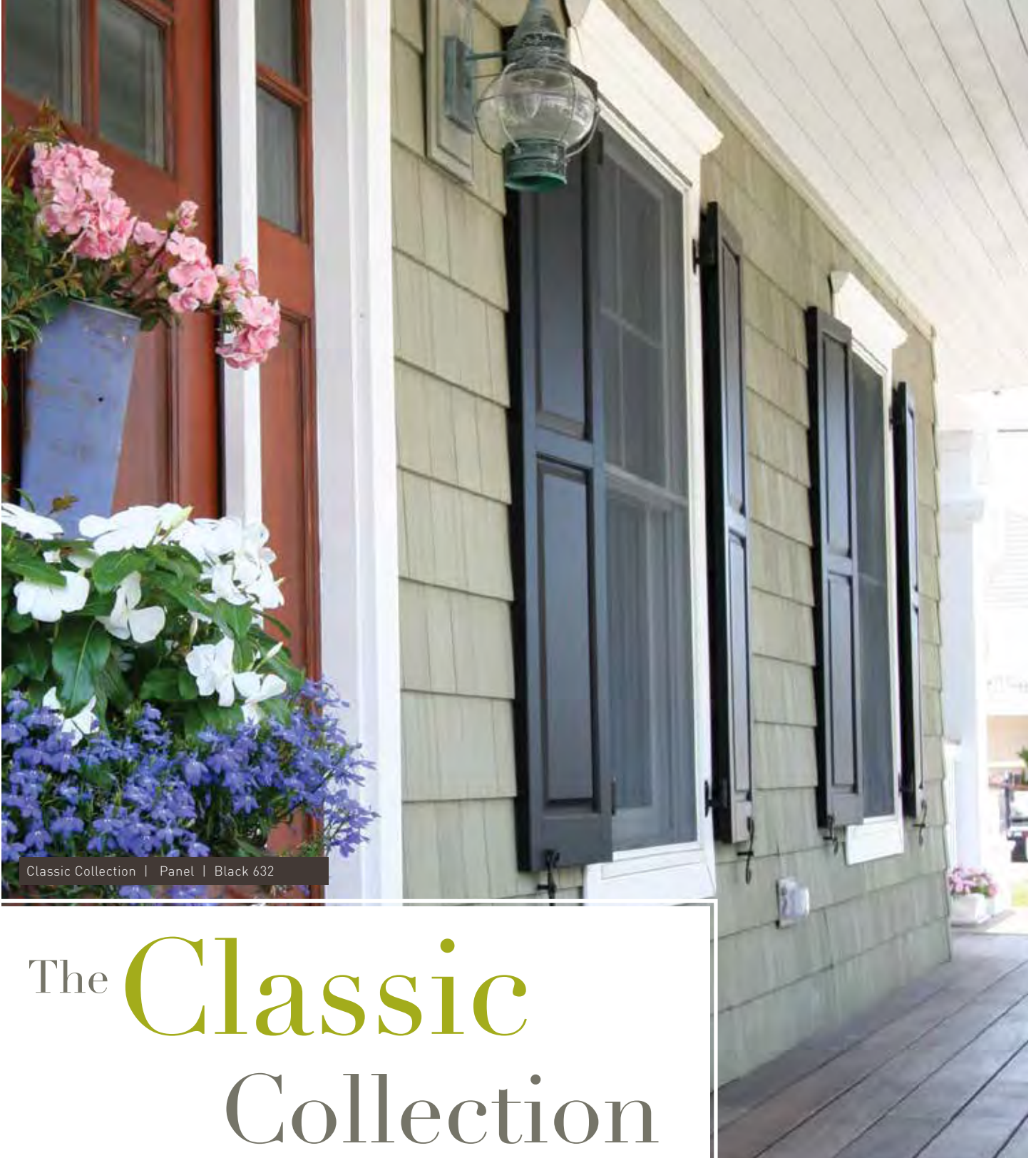

The **Classic**
Collection

Dimension that truly helps you stand out.

Skillfully Handcrafted

Whether operable or fixed to the home, Classic Collection shutters give any home eye-catching dimensions that truly let it stand out. Skillfully handcrafted, these shutters are available in the popular Board and Batten, Panel and Faux Louver designs.

Uncompromising Craftsmanship

Classic Collection shutters are hand-crafted from our proprietary, exterior grade composite wood, including panels, stiles, rails and closed louvers. Components are machine and hand sanded, then hand assembled using tongue and groove joinery techniques that have been employed by skilled craftsmen for ages.

Enduring Beauty

An exclusive finishing process ensures the color you select holds its richness. It begins with two coats of durable, marine-grade primer, followed by specially-formulated industrial-grade 2-part urethane finish paint. Atlantic's unique oven-curing process hardens the finish paint into a protective shell with deep, vibrant color, permanently bonding the shutter material for extreme durability.



Panel

Classic Collection Panel shutters are an ideal accent for giving a home intimate character and attractive warmth. Their traditional design offers eye-catching dimension for a complete range of designs and exterior materials. Classic Collection Panel shutters are offered with numerous options. An extra panel creates unmistakably rich texture; a single panel provides stately, crisp lines; popular arch or radius tops perfectly complement shaped windows for scenic custom looks.



Standard



Single Panel



Extra Panel



Custom Rail Location



Arch or Radius Top



Panel | Pine 644



Flat Panel



V-Groove Flat Panel

The **Classic** Collection



Faux Louver | Deep Sea Blue 637

Faux Louver

Atlantic's Faux Louver shutters use a unique patented process that delivers a beautiful louvered appearance. These shutters add a classic, traditional look with rhythmic, clean lines. Enhancing a variety of home styles, Faux Louver shutters offer the popular option of an additional rail, accentuating both horizontal and vertical appeal. Rails also accommodate optional sliding-bolt hardware for a more handsome operable-shutter application. Arch and radius top shutters are also available to match this popular window design.





Faux Louver | Custom Color

The **Classic** Collection

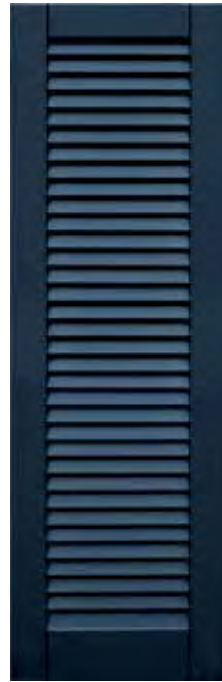

Standard



Additional Rail



Arch top



Board and Batten

With bold dimension and solid, colorful character, Board and Batten shutters distinguish homes with Old-World charm and a flourish of rustic style. These shutters offer a classic aesthetic for a variety of homes. Board and Batten shutters are a favorite choice for picturesque forest and lake homes. Popular options include z-bars, extra battens and arch or radius tops. To ensure historical accuracy, vertical grooves are approximately every 4 inches.

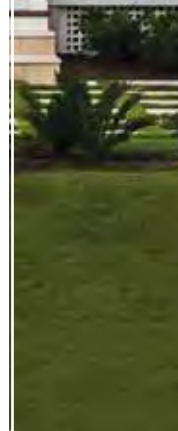

Standard



Z-Bar



Extra Batten



No Battens



Arch or Radius Top



Board and Batten | Walnut 641

The Pro Series

Atlantic's ProSeries Shutters are hand-assembled from exterior-grade composite wood components that will not rot, crack or split. ProSeries Shutters come ready to be painted with any high-quality exterior paint of your choice.



Louver



Raised Panel

Stand out from the crowd

Design details complete the front and back of each shutter, with four handsome styles available: Louver, Raised Panel, Flat Panel and Board and Batten. Corners and joints are true and square with tongue and groove construction that provides superior strength.

Each ProSeries shutter is machine sanded and finished with a single coat of marine-grade primer, reducing your time in applying a finish coat of paint.

The choice for versatility, custom color and outstanding charm.



Flat Panel



Board and Batten

Versatile

ProSeries shutters can be specified to correct window scale or sized as desired. Widths are available from 12" to 24" in half-inch increments; heights from 30" to 84" in inch increments. Quarter Round Arch Tops are also available. ProSeries shutters may be installed in fixed or operable applications and are backed by a 3-year structural warranty.

Unique Cut-outs

Anything but cookie-cutter.



Nothing provides warmth like a personal touch. With our standard and custom cut-out capabilities, you can enhance your home with inviting charm and a singular, beautiful look.

From stars to crescent moons and palm trees, cut-outs add eye-catching dimension and uncommon style, while at the same time letting your individuality shine through.

Standard cut-outs

Palm, Moon, Pineapple, Anchor, Star, Heart, Tree, Diamond and Sailboat.

Unique Cut-outs



Classic Collection | Raised Panel | Anchor Cut-out | Harbor 645

Authentic Hardware



A detail no one will miss.

Our architecturally-correct and historically accurate hardware is a small detail that speaks volumes to the attentive style of your home. An ornament in themselves, they evoke the craftsmanship of a blacksmith forging clean, elegantly simple architectural elements.

For fixed mounting applications, a clean finish is possible by using our clear polycarbonate L-brackets. Bahama shutters use aluminum hardware that is available in a mill or anodized aluminum black finish.



Providing full utility, our durable hardware is forged from 304 series stainless steel with a matte black, powder coat finish. From depth-enhancing Slide Bolts to smoothly attractive "S" Holdbacks and Rat-tail Holdbacks, hardware pieces amplify style with endearing simplicity.

When shutters are in the open position, our traditional hardware adds beautiful dimension by setting the shutters off from the home, allowing a hint of exterior cladding to be visible between each shutter leaf and the structure for a noticeable fine touch.

Impact-Resistant Storm Shutters



Bahama Storm System
Can be locked from the inside and outside



"U" Locking Storm Bar System
Locks from the inside



Horizontal Storm Bar System
Locks from the outside

You can count on Atlantic's Impact-Resistant storm shutters to protect your coastal home. Atlantic's Inside Locking U-Shaped Storm Bar System features two U-shaped storm bars that lock from the interior when the shutters are closed. Each shutter leaf has a 1/8" thick clear polycarbonate panel fastened to its back, helping protect the shutter leaf, the window and your home's interior. The system meets the Large Missile Impact Test requirement as specified in the IRC and IBC 2006.

The system is available for Architectural shutters in Louver or Raised Panel styles (does not apply to arch and radius top shutters, cut-outs, combination styles, flat panel, or v-groove). When your shutters are in the open position, the polycarbonate backing remains hidden from view, so your home evokes a scenic, seamless charm.



High Level of Home Protection

The Bahama Storm System offers the same high level of home protection, but with our unique Bahama style Architectural Collection Shutters that offer sleek, versatile aesthetics. A 1/8" thick clear polycarbonate panel is permanently attached to the back of the shutter. A camelback locking system specifically designed for the Bahama style is installed along the sides of the shutter. With the Bahama Storm System, you gain privacy, ambient light, fresh air, and home-protecting toughness independently tested to a design pressure of 60 PSF.

The Bahama Storm System meets the Large Missile Impact Test requirement as specified in the IRC and IBC 2006. This system also meets the State of Florida Building Code 2007.

Color



Black
632



Charleston Green
653



Rookwood Shutter Green
654



Roycraft Bottle Green
655



Deep Sea Blue
637



Tempest Blue
666



Hamilton Blue
667



Harbor
645

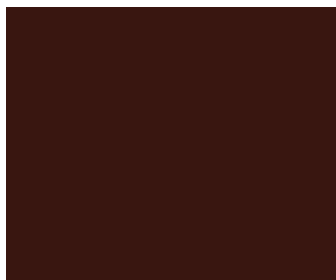

Polished Mahogany
657



Federal Brown
635

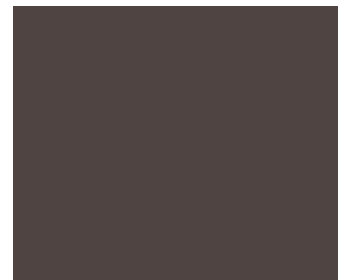

Walnut
641



Rookwood Medium Brown
658



Pewter
646



Chelsea Gray
662



Roycraft Mist Gray
664

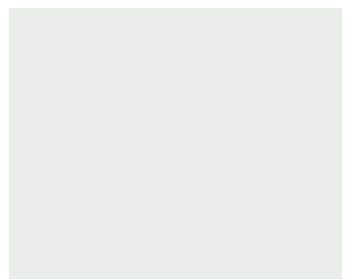

White
631

Visually Striking Colors to Set you Apart.



Evergreen
638



Forest Green
633



Pine
644



Midnight Sky
639



Cascade
647

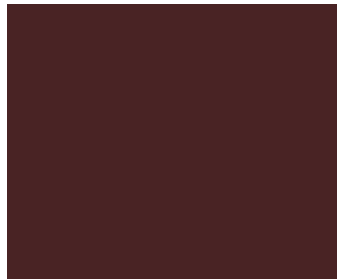

Bordeaux
640

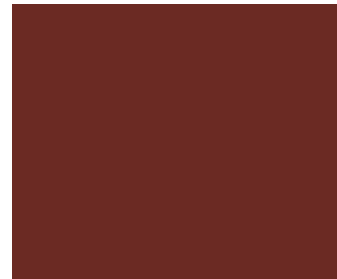

Roycraft Copper Red
668

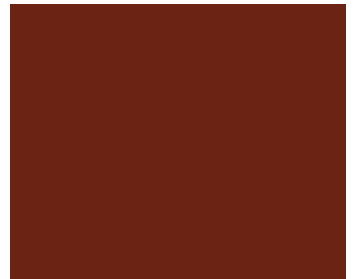

Board & Batten Red
650

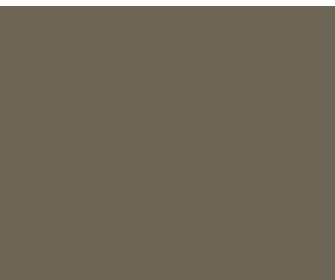

Weathered Shingle
660



Sand
642

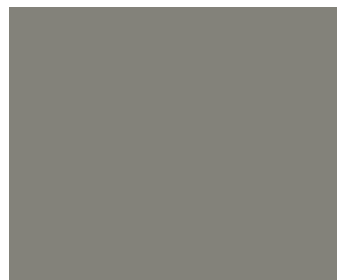

Hammered Silver
661



Roycraft Pewter
663

ARCHITECTURAL COLLECTION



Installation: To be installed in either a operable or fixed application in accordance with manufacturer's recommendations, with no nailing or screwing through face of shutter. See installation instructions for measuring and ordering.

Hardware – Colonial style shutters: Black powder coated stainless steel, all other fasteners also to be stainless steel.

Hardware – Bahama: Aluminum mill or anodized aluminum black finish arms. Hinges are aluminum with factory-applied two-part acrylic urethane finish.

Performance: All fiberglass louvers and side rails to be thermally stable from -100°F to +200°F.

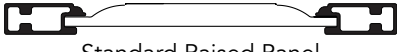
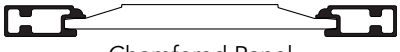
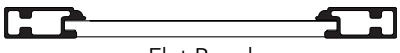
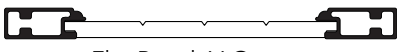
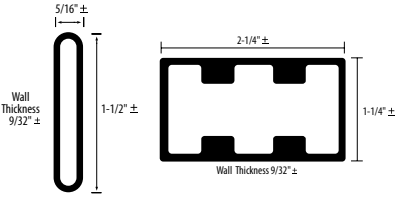
Warranties: Limited Lifetime against defects in materials and factory paint finish. Limited to original purchaser. See warranty for complete details.

PANEL	LOUVERED COLONIAL	COMBINATION
 <p>Standard Raised Panel</p>  <p>Chamfered Panel</p>  <p>Flat Panel</p>  <p>Flat Panel, V-Groove</p>		 <p>Consists of louver and panel components</p>

Rails	Structural PVC with smooth outer skin		
Panels	Proprietary exterior grade composite wood materials	N/A	Structural PVC with smooth outer skin
Louvers	N/A	Pultruded Structural Fiberglass	
Stiles	Pultruded Structural Fiberglass		
Primer	Entire product primed	N/A	Entire product primed
Paint Finish	Industrial grade two-part urethane, oven cured finish. 31 standard colors (custom colors available).		
Thickness	1"	1-1/4"	1-1/4"
Width	12" - 30" (in 1/8" increments)	9" - 30" (in 1/8" increments) <i>Rail widths, if specified, may vary slightly due to louver/slat positioning</i>	12"-30" (in 1/8" increments) <i>Rail widths, if specified, may vary slightly due to louver/slat positioning</i>
Height	24" - 119" (in 1/8" increments)	13-1/2" - 119" (in 1/8" increments)	24" - 119" (in 1/8" increments)
Vertical Stile	2-1/4"	2-1/4"	2-1/4"
Top Rail	3"	Standard 4"	4"
Middle Rail	3"	Standard 3-3/8"	4"
Bottom Rail	3"	Standard 4" (may vary)	4"
Custom Rail Height	N/A	Available 1-1/4" increments from standard rail	
Louver Angle	N/A	25°	
Addl Rail	N/A	3-3/8" or may vary 1-1/4" increments	3-3/8" or may vary 1-1/4" increments

ARCHITECTURAL COLLECTION

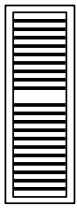

Less than 30"
With Mid-Rail

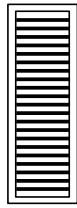

Less than 30"

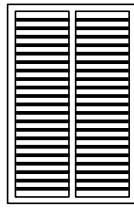

Widths from
30" – 59.875" require
1 vertical mullion
(automatically added).

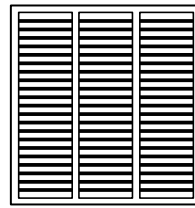

Widths from
60" – 89.875" require
2 vertical mullions
(automatically added).

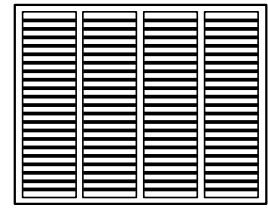

Widths from
90" – 119" require
3 vertical mullions
(automatically added).

BAHAMA

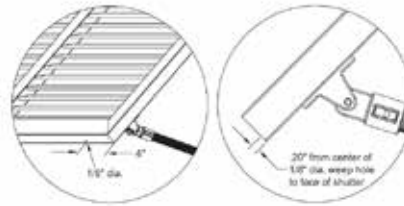
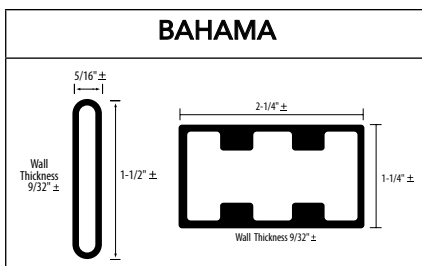

Optional:

Weep hole 1/8" inch diameter on each side of the shutter. Must be requested.

Rails	Pultruded Structural Fiberglass
Slats	
Stiles	
Paint Finish	Two-part Urethane
Thickness	1-1/4"
Width	12" - 119" (in 1/8" increments)
Height	18-1/2" - 119" (in 1-1/2" increments)
Vertical Stile	2-1/4"
Top Rail	2-1/4"
Middle Rail	2-3/4"
Bottom Rail	2-1/4"
Louver Angle	36°
Prop Arm Angle	30°

Available Bahama Shutter Heights (Inches)

18.5	27.5	36.5	45.5	54.5	63.5	72.5	81.5	90.5	99.5	108.5	119
20	29	38	47	56	65	74	83	92	101	110	
21.5	30.5	39.5	48.5	57.5	66.5	75.5	84.5	93.5	102.5	111.5	
23	32	41	50	59	68	77	86	95	104	113	
24.5	33.5	42.5	51.5	60.5	69.5	78.5	87.5	96.5	105.5	111	
26	35	44	53	62	71	80	89	98	107	117.5	

CLASSIC COLLECTION

Installation: To be installed in a fixed or operable application in accordance with manufacturer's recommendations, with no nailing or screwing through face of shutter. Classic Raised Panel and Louver only can be installed operable.

Hardware: Clear polycarbonate mounting brackets for fixed mounting. Black powder coated stainless steel for operable mounting.

Warranties: 10 Year against defects in materials and factory paint finish. Limited to original purchaser. See warranty for complete details.

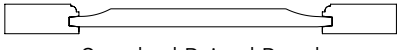
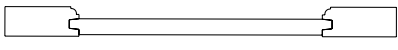
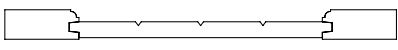
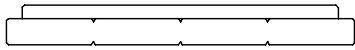
	PANEL	FAUX LOUVER	BOARD AND BATTEN
	 Standard Raised Panel  Flat Panel  Flat Panel, V-Groove	NA	

Rails	Proprietary Exterior Grade Composite Wood		
Panels			
Stiles			
Primer	Marine Grade		
Paint Finish	Industrial grade two-part urethane, oven cured finish. 31 standard colors (custom colors available).		
Thickness	—	—	1", Batten is 1/2"
Width	12"–24" (in 1/8" increments)	9"–24" (in 1/8" increments)	
Height	13-1/2"–96" (in 1/8" increments)		13-1/2"–84" (in 1/8" increments)
Batten Height	—	—	4"
Batten Width	—	—	1-1/2" Less than shutter width
Board Width	—	—	Grooves are cut approx. every 4"

RAISED PANEL

- Thickness:** 1"
- Vertical Stile Width (A):** 2-1/2"
- Top Rail Height (B):** 2-1/2"
- Middle Rail Height (C):** 2-1/2"
- Bottom Rail Height (D):** 4-1/8"

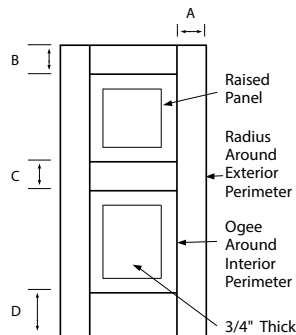

FLAT PANEL

- Thickness:** 1"
- Vertical Stile Width (A):** 2-1/2"
- Top Rail Height (B):** 2-1/2"
- Middle Rail Height (C):** 2-1/2"
- Bottom Rail Height (D):** 4-1/8"

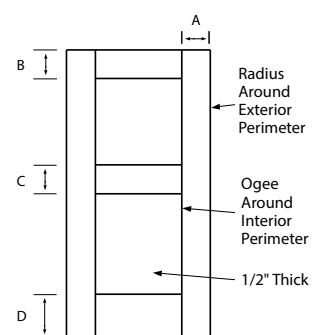

PANEL, V-GROOVE

- Thickness:** 1"
- Vertical Stile Width (A):** 2-1/2"
- Top Rail Height (B):** 2-1/2"
- Middle Rail Height (C):** 2-1/2"
- Bottom Rail Height (D):** 4-1/8"

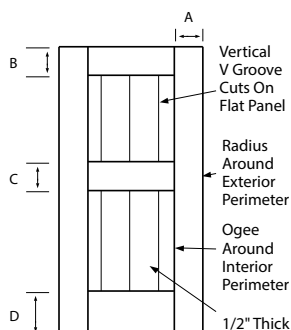

LOUVER

- Thickness:** 1-1/4"
- Vertical Stile Width (A):** 2-1/2"
- Top Rail Height (B):** 2-1/2"
- Middle Rail Height (C):** 2-1/2"
- Bottom Rail Height (D):** 2-3/4"–4"
- Louver Angle:** 22°

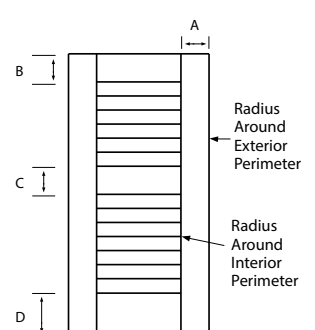

PROSERIES

Atlantic's ProSeries shutters are hand-assembled from exterior-grade composite wood components that will not rot, crack or split. ProSeries shutters come ready to be painted with any high-quality exterior paint of your choice. Each shutter is machine sanded and finished with a single coat of marine-grade primer reducing your time in applying a finish coat of paint.

ProSeries shutters are available in four different styles.

- Louver, Raised Panel, Flat Panel, Board and Batten.
- Quarter Round Arch Tops are available on all styles.

ProSeries shutters are available in the following sizes.

- Widths 12" to 24" in 1/2" increments.
- Heights 30" to 84" in 1" increments.

ProSeries shutters are primed only and should receive a finish coat of paint.

- Any good quality exterior grade finish paint should be used.
- Each shutter should be scuffed with a fine grit sandpaper prior to application of the finish paint coat.

Hardware for ProSeries Shutters is provided separately.

ProSeries shutters are backed by a 3 year structural warranty.

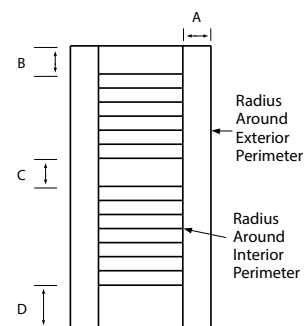
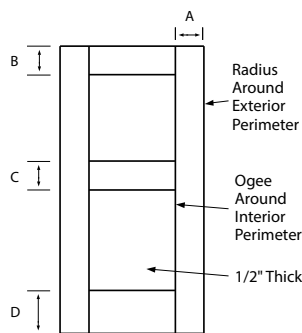
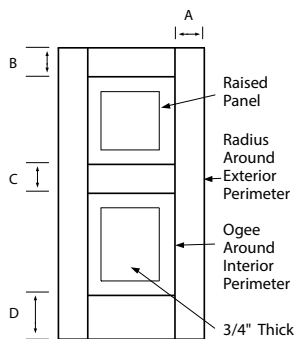

TRADITIONAL HARDWARE



Pintel on Plate

- Sold in pairs
- Pintel plate - 1-1/2" x 3-1/2" x 1/8"
- Pin diameter - 3/8"
- Stainless steel with a matte black powder coat finish
- Offsets: 1/2", 1-1/2", 2-1/4", 3-1/2"



Jamb Pintel

- Sold in pairs
- Stainless steel with a matte black powder coat finish
- Offsets: 1/2", 1", 2"



4" Lag Pintel

- Sold in pairs
- Stainless steel with a matte black powder coat finish
- Pin diameter: 3/8"



Pintel Shim

- Sold as each
- Shim is 1/4" thick and stackable
- Black polyamide plastic



6" L-Hinge

- Sold in same size pairs
- Stainless Steel with a matte black powder coat finish
- Offsets: 0", 1/2", 1-1/2", 2-1/4"



Flat Hinge

- Sold in pairs
- Stainless Steel with a matte black powder coat finish
- Offsets: 0", 1/2", 1-1/2", 2-1/4"



No Throw 6" L-Hinge

- Sold in same size pairs
- Stainless steel with a matte black powder coat finish
- Offset: 0"



No Throw Flat Hinge

- Sold in pairs
- Stainless steel with a matte black powder coat finish
- Offset: 0"



Strap Hinge

- Sold in pairs
- Stainless steel with a matte black powder coat finish
- Two sizes, 10" and 12"
- 10" Offsets: 0", 1/2", 1-1/2", 2-1/4"
- 12" Offsets: 1/2", 1-1/2"



Decorative Hinge

- Sold in pairs
- Stainless steel with a matte black powder coat finish
- Non-operable
- Two sizes, 10" and 12"



6" Lag Bolt

- Sold in pairs
- Stainless Steel with a matte black powder coat finish
- For use with "S" and Rat-Tail Holdbacks



12" Slide Bolt

- Sold as each
- Stainless Steel with a matte black powder coat finish
- Two options, standard and locking



Acorn Holdback

- Sold as each
- Chromed Bronze Bullet
- Solid steel hanger bolt and spring clip



Dog Post Holdback

- Sold as each
- Stainless steel with a matte black powder coat finish



"S" Holdback

- Sold in pairs with 4" lag bolt, washer and cotter pin
- Stainless steel with a matte black powder coat finish



Rat-Tail Holdback

- Sold in pairs with 4" lag bolt, washer and cotter pin
- Stainless steel with a matte black powder coat finish

To deflect rain away from the structure, louvered shutters should be installed so the louvers face AWAY from the structure when shutters are closed.

Shutter swing is 3" per shutter from the edge of the open shutter to the edge of the window opening when the shutter is closed; be sure to check for proper clearance (i.e. lamps, fixtures) when the shutter is in the open position.

Hinges are usually applied to the back of the shutter. They are only visible in their entirety when the shutter is in the closed position.

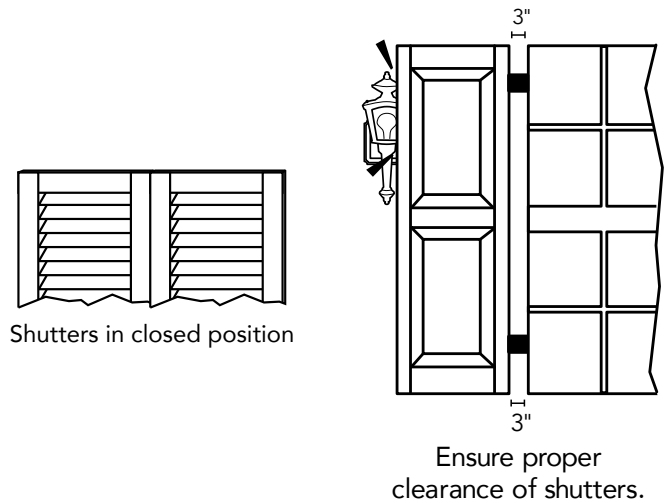

EXAMPLES OF COMMON INSTALLATION OPTIONS - TRADITIONAL HARDWARE

HINGE REQUIREMENTS

Shutter Height	12" to 48"	49" to 96"	97" to 108"
Hinge Requirement	2	3	4

Projected

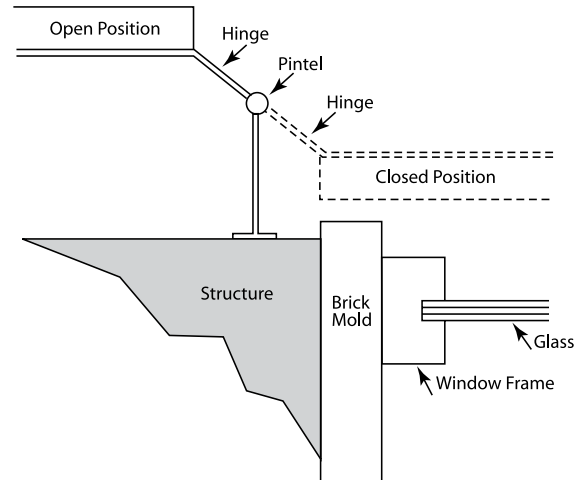

Recessed

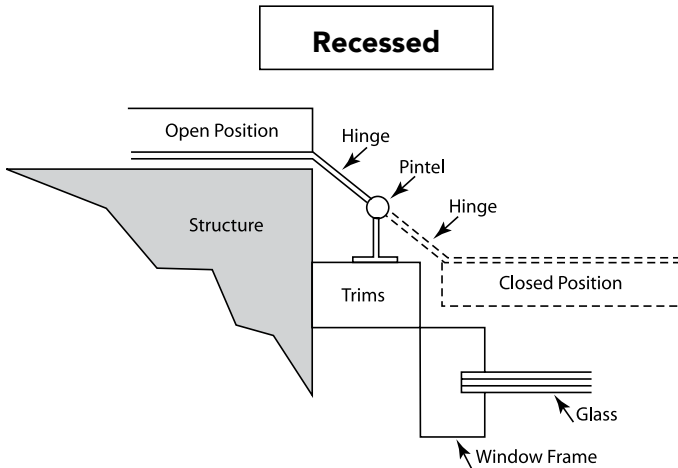

Flush

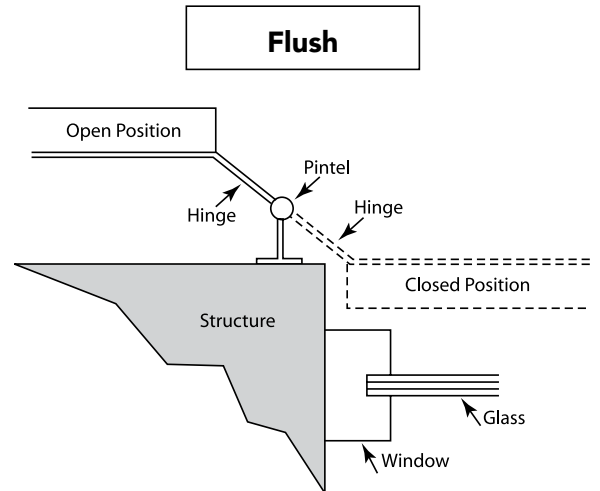

FIXED MOUNTING HARDWARE

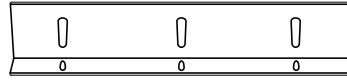

Fixed Mounting Bracket

- Sold in 4-piece set
- Clear polycarbonate
- Sizes 9", 14", 18"
- 4" Side bracket included for shutters over 48" tall

BAHAMA HARDWARE

NOTE: Female hinge clearance is not factored into overall shutter height.

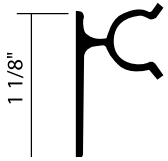

Male Hinge

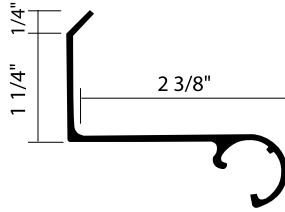

2 - 3/8" Female Hinge

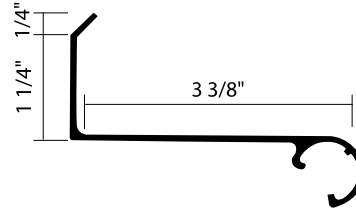

3 - 3/8" Female Hinge

TILT ARM COMPONENT PARTS

Aluminum tilt arms with nylon end caps



Stainless steel clevis pin



Nylon hinges/eye-end sets

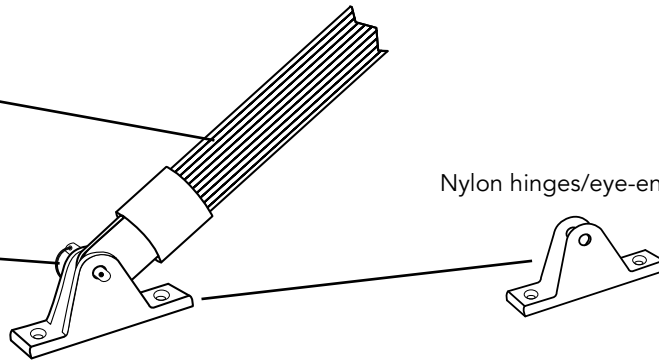

Examples of Common Installation Options - Bahama Hardware

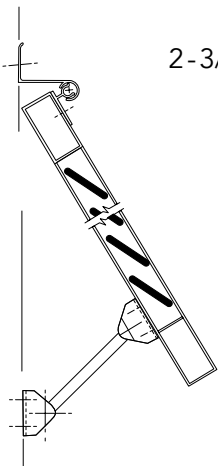

2-3/8" Female Hinge
Flush Mount

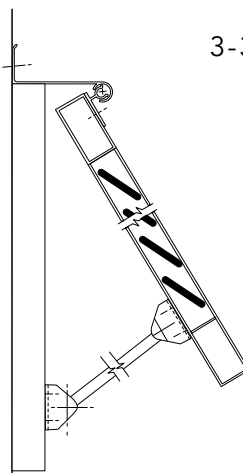

3-3/8" Female Hinge
Deep Set

IMPACT RESISTANT STORM SHUTTER HARDWARE & STORM BAR SYSTEMS



Inside Locking "U" Shaped Storm Bar System

The Inside Locking "U" Shaped Storm Bar System meets the Large Missile Impact Test requirement as specified in the IRC and IBC 2006.

- Available for Architectural Collection Louver and Raised Panel shutters. Does not apply to arch and radius top shutters, cutouts, combination, bi-folds, flat-panel, or v-groove.
- Shutters can be ordered in 1/8" increments to a maximum size of 30" width and 96" length per shutter leaf.
- Each shutter leaf has a clear (1/8" thick) polycarbonate panel fastened to the back.

If shutter is over 46 inches, 2 Inside Locking "U" Shaped Storm Bars are required per shutter pair.

- Storm bar length 6", height 2", thickness 1/8", projection 1"
- Storm bars require installation by the shutter installer.
- Bolts and wing nuts are provided.

If Shutter is under 46 inches, it only requires 1 Inside locking "U" Shaped Storm Bar.

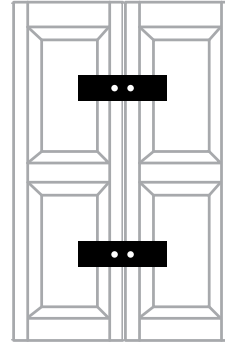

"U" Shaped Storm Bar

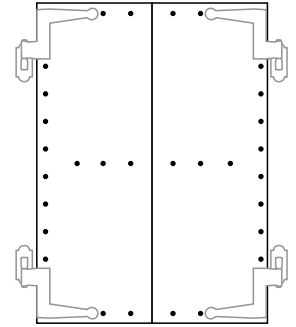

Polycarbonate Panel

Horizontal Storm Bar System

Can be ordered in 1/8" increments to a maximum size of 60" w x 96" h window opening (shutter width of 30").

If shutter is over 46 inches, 2 Horizontal Storm Bars required per shutter pair.

- Storm bar length needs to match the total width of the shutter pair.
- Storm bars require installation by shutter installer.
- Bolts and wing nuts are provided.

If Shutter is under 46 inches, it only requires 1 Horizontal Storm Bar.

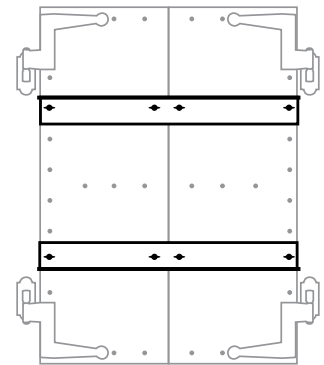

Horizontal Storm Bar

Bahama Storm System

The Bahama Storm System meets the State of Florida Building Code 2010.

- Architectural Collection Bahama style shutter.
- Shutters can be ordered in 1/8" width and 1-1/2" height increments to a maximum of 60" w x 103" h.
- Each shutter has a clear (1/8" thick) polycarbonate panel fastened to the back.

A camelback locking system is installed along the sides of the shutter, provided at no charge.

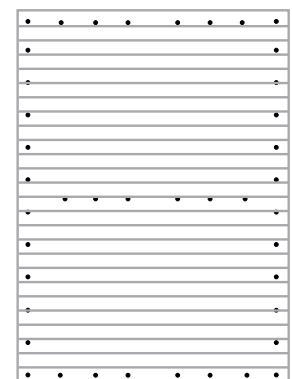

Bahama

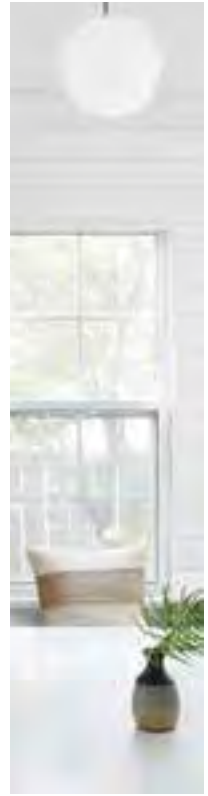

BOUNDLESS™

Where some see boundaries, Westlake Royal Building Products™ sees opportunities to drive innovation, elevate design and deliver solutions that redefine the industry. Our comprehensive selection of products, materials and widely expressive color palettes and textures meet any home demand—inside and out, East Coast to West. Giving everyone the tools and technology to transform spaces into anything they want. This is our mission. And it's Boundless™.

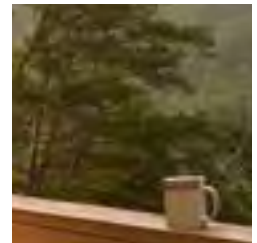
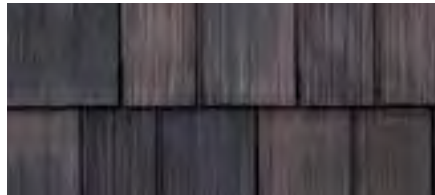

SIDING & ACCESSORIES

TRIM & MOULDINGS

ROOFING

STONE

WINDOWS

OUTDOOR LIVING

